



YASKAWA

# YASKAWA AC Drive-V1000 Option **MECHATROLINK-II** Technical Manual

Type: SI-T3/V

To properly use the product, read this manual thoroughly and retain for easy reference, inspection, and maintenance. Ensure the end user receives this manual.

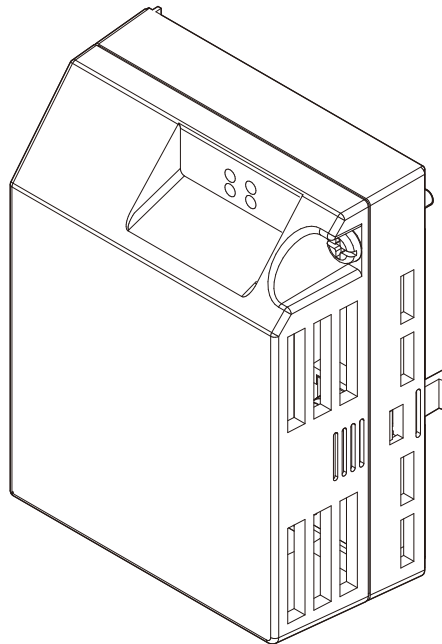

**This Page Intentionally Blank**



# Table of Contents

---

<b>1 PREFACE AND SAFETY</b> .....	<b>5</b>
<b>2 PRODUCT OVERVIEW</b> .....	<b>9</b>
<b>3 RECEIVING</b> .....	<b>10</b>
<b>4 MECHATROLINK-II OPTION COMPONENTS</b> .....	<b>11</b>
<b>5 INSTALLATION PROCEDURE</b> .....	<b>13</b>
<b>6 MECHATROLINK OPTION DRIVE PARAMETERS</b> .....	<b>18</b>
<b>7 TRANSMISSION INTERFACE</b> .....	<b>19</b>
<b>8 MECHATROLINK-II COMMANDS</b> .....	<b>22</b>
<b>9 TROUBLESHOOTING</b> .....	<b>34</b>
<b>10 SPECIFICATIONS</b> .....	<b>41</b>

---

**Copyright © 2008 YASKAWA ELECTRIC CORPORATION**

All rights reserved. No part of this publication may be reproduced, stored in a retrieval system, or transmitted, in any form, or by any means, mechanical, electronic, photocopying, recording, or otherwise, without the prior written permission of Yaskawa. No patent liability is assumed with respect to the use of the information contained herein. Moreover, because Yaskawa is constantly striving to improve its high-quality products, the information contained in this manual is subject to change without notice. Every precaution has been taken in the preparation of this manual. Nevertheless, Yaskawa assumes no responsibility for errors or omissions. Neither is any liability assumed for damages resulting from the use of the information contained in this publication.

# 1 Preface and Safety

Yaskawa manufactures products used as components in a wide variety of industrial systems and equipment. The selection and application of Yaskawa products remain the responsibility of the equipment manufacturer or end user. Yaskawa accepts no responsibility for the way its products are incorporated into the final system design. Under no circumstances should any Yaskawa product be incorporated into any product or design as the exclusive or sole safety control. Without exception, all controls should be designed to detect faults dynamically and fail safely under all circumstances. All systems or equipment designed to incorporate a product manufactured by Yaskawa must be supplied to the end user with appropriate warnings and instructions as to the safe use and operation of that part. Any warnings provided by Yaskawa must be promptly provided to the end user. Yaskawa offers an express warranty only as to the quality of its products in conforming to standards and specifications published in the Yaskawa manual. **NO OTHER WARRANTY, EXPRESSED OR IMPLIED, IS OFFERED.** Yaskawa assumes no liability for any personal injury, property damage, losses, or claims arising from misapplication of its products.

## ◆ Applicable Documentation

The following manuals are available for the MECHATROLINK-II Option:

### Option Unit

	<b>V1000 Option MECHATROLINK-II Installation Manual</b> Manual No. : TOBPC73060049
	Read this manual first. The installation manual is packaged with the MECHATROLINK-II Option and contains a basic overview of wiring, settings, functions, and fault diagnoses.
	<b>V1000 Option MECHATROLINK-II Technical Manual (this book)</b> Manual No. : SIEPC73060049
	The technical manual contains detailed information and command registers. To obtain the technical manual access the site below: <a href="http://www.e-mechatronics.com">http://www.e-mechatronics.com</a>

### Yaskawa Drive

	<b>V1000 Series AC Drive Technical Manual</b>
	This manual describes installation, wiring, operation procedures, functions, troubleshooting, maintenance, and inspections to perform before operation. To obtain instruction manuals for Yaskawa products access the site below: <a href="http://www.e-mechatronics.com">http://www.e-mechatronics.com</a>
	<b>V1000 Series AC Drive Quick Start Guide</b>
	This guide is packaged together with the product. It contains basic information required to install and wire the drive. This guide provides basic programming and simple set-up and adjustment.

## ◆ Terms

**Note:** Indicates supplementary information that Yaskawa highly recommends be followed, even though equipment may not be at risk.

**Drive:** Yaskawa AC Drive-V1000 Series

**MECHATROLINK-II Option:** Yaskawa AC Drive-V1000 Option MECHATROLINK-II

**≥ 1016:** Indicates a drive feature or function that is only available in drive software version 1016 or later.

### ◆ Registered Trademarks

- MECHATROLINK-I/MECHATROLINK-II is a registered trademark of the MECHATROLINK Members Association (MMA).
- Other company names and product names listed in this manual are registered trademarks of those companies.

### ◆ Supplemental Safety Information

Read and understand this manual before installing, operating, or servicing this option unit. The option unit must be installed according to this manual and local codes.

The following conventions are used to indicate safety messages in this manual. Failure to heed these messages could result in serious or possibly even fatal injury or damage to the products or to related equipment and systems.

#### DANGER

Indicates a hazardous situation, which, if not avoided, will result in death or serious injury.

#### WARNING

Indicates a hazardous situation, which, if not avoided, could result in death or serious injury.

#### CAUTION

Indicates a hazardous situation, which, if not avoided, could result in minor or moderate injury.

#### NOTICE

Indicates an equipment damage message.

### ■ General Safety

#### General Precautions

- The diagrams in this section may include option units and drives without covers or safety shields to illustrate details. Be sure to reinstall covers or shields before operating any devices. The option should be used according to the instructions described in this manual.
- Any illustrations, photographs, or examples used in this manual are provided as examples only and may not apply to all products to which this manual is applicable.
- The products and specifications described in this manual or the content and presentation of the manual may be changed without notice to improve the product and/or the manual.
- When ordering a new copy of the manual due to damage or loss, contact your Yaskawa representative or the nearest Yaskawa sales office and provide the manual number shown on the front cover.

#### DANGER

**Heed the safety messages in this manual.**

Failure to comply will result in death or serious injury.

The operating company is responsible for any injuries or equipment damage resulting from failure to heed the warnings in this manual.

**NOTICE**

Do not expose the drive to halogen group disinfectants.

Failure to comply may cause damage to the electrical components in the option unit.

Do not pack the drive in wooden materials that have been fumigated or sterilized.

Do not sterilize the entire package after the product is packed.

**Do not modify the drive circuitry.**

Failure to comply could result in damage to the drive and will void warranty.

YASKAWA is not responsible for any modification of the product made by the user. This product must not be modified.

### ■ Option Unit Label Warnings

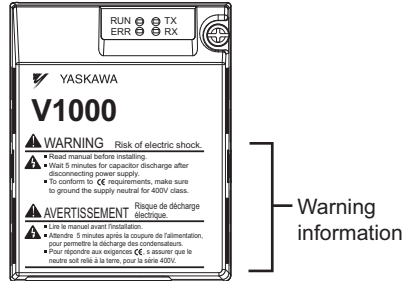

Warning information is displayed on the option unit as shown in the figure below. Follow all warnings and safety instructions when using the product.

When using the drive in an area that may require displaying warning information in Japanese or Chinese, a warning label sticker is provided with the MECHATROLINK-II Option. This sticker can be placed over the English and French warnings on the front of the MECHATROLINK-II Option.





### ■ Warning Contents

#### **WARNING** Risk of electric shock.

-  Read manual before installing.
-  Wait 5 minutes for capacitor discharge after disconnecting power supply.
-  To conform to **CE** requirements, make sure to ground the supply neutral for 400V class.

#### **AVERTISSEMENT** Risque de décharge électrique.

-  Lire le manuel avant l'installation.
-  Attendre 5 minutes après la coupure de l'alimentation, pour permettre la décharge des condensateurs.
-  Pour répondre aux exigences **CE**, s'assurer que le neutre soit relié à la terre, pour la série 400V.



## 2 Product Overview

### ◆ About This Product

MECHATROLINK-II Option (Model: SI-T3/V) is designed for connecting a drive to a field network using the MECHATROLINK protocol.

By installing the MECHATROLINK-II Option to a drive, it is possible to do the following from a MECHATROLINK master device:

- operate the drive
- monitor the operation status of the drive
- change parameter settings.

### ◆ Applicable Model

The MECHATROLINK-II Option can be used with the drive models in [Table 1](#).

**Table 1 Applicable Model**

Drive	Software Version <1>
V1000	≥ 1016

<1> See “PRG” on the drive nameplate for the software version number.

## 3 Receiving

Please perform the following tasks after receiving the MECHATROLINK-II Option:

- Inspect the MECHATROLINK-II Option for damage.  
If the MECHATROLINK-II Option appears damaged upon receipt, contact the shipper immediately.
- Verify receipt of the correct model by checking the information on the nameplate (see [Figure 1](#)).
- If you have received the wrong model or the MECHATROLINK-II Option does not function properly, contact your supplier.

### ◆ Contents and Packaging

Table 2 Contents of Package

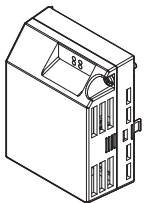
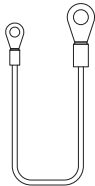
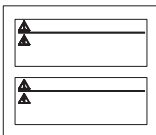
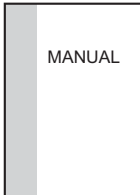
Description:	Option Unit	Ground Cables	Warning Label Stickers	Installation Manual
-				
Quantity:	1	4	1	1

### ◆ Tool Requirements

A Phillips screwdriver (#2, #3 <1>) U.S. standard size is required to install the MECHATROLINK-II Option.

<1> Screw sizes vary by drive capacity. Select a screwdriver that matches the drive ground terminal (M3.5 to M6).

## 4 MECHATROLINK-II Option Components

### ◆ MECHATROLINK-II Option

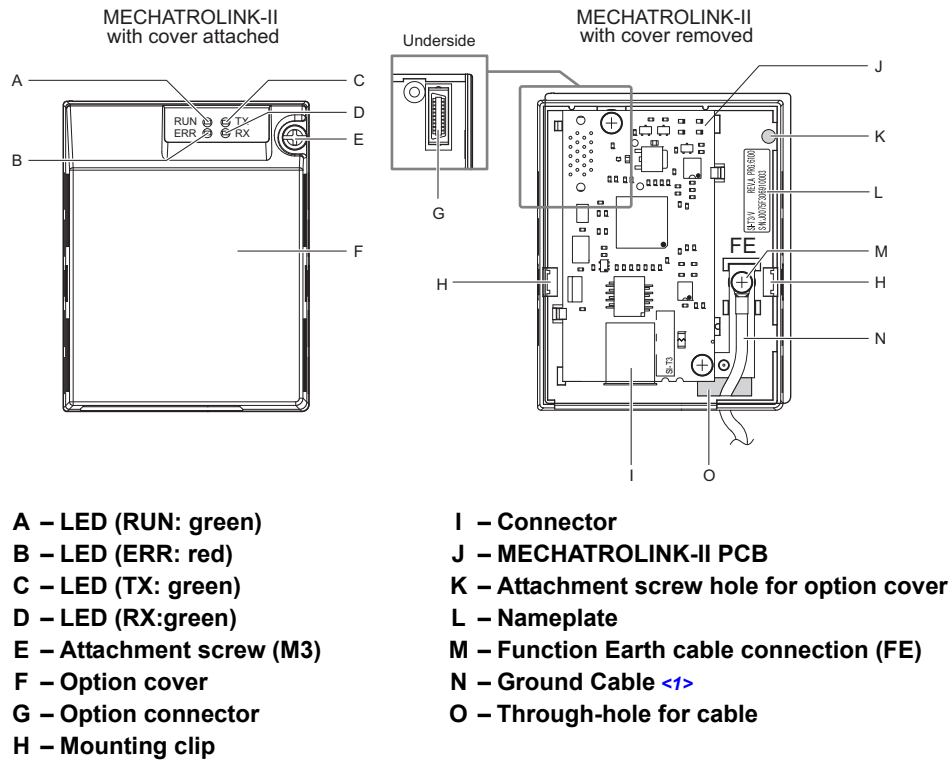

<1> Cables are not connected to the MECHATROLINK-II Option and are packaged separately in the box.

Figure 1 Option Unit

**Note:** For details on the LEDs, [Refer to MECHATROLINK-II Option LED Display on page 12.](#)

### ◆ Dimensions

The installed MECHATROLINK-II Option adds 27 mm to the total depth of the drive.

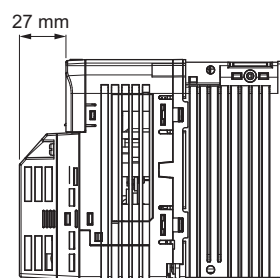
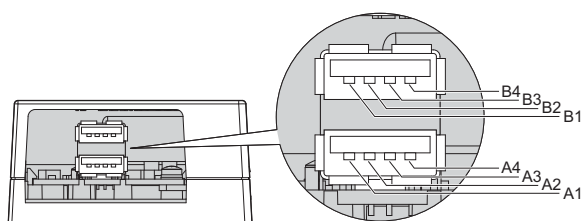

Figure 2 Dimensions

### ◆ Connector

**Table 3 Connector Descriptions**

Connector	Pin No.	Signal Name	I/O	Function
CN3	A1	(NC)	–	Not used.
	A2	SRD–	I/O	Send/receive data (–)
	A3	SRD+	I/O	Send/receive data (+)
	A4	(NC)	–	Not used.
	Shell	SLD	–	Shield
	B1	(NC)	–	Not used.
	B2	SRD–	I/O	Send/receive data (–)
	B3	SRD+	I/O	Send/receive data (+)
	B4	(NC)	–	Not used.
Shell	SLD	–	Shield	



**Figure 3 MECHATROLINK-II Option Connector**

### ◆ MECHATROLINK-II Option LED Display

**Table 4 MECHATROLINK-II Operation LED Status**

LED	Display	Status	Remarks
RUN	ON	Power supply on	SI-T3/V has been successfully powered up
	OFF	No power	<ul style="list-style-type: none"> <li>The drive has no power</li> <li>SI-T3/V is not properly connected to the drive, or SI-T3/V has no power</li> <li>An internal, self-diagnostic error occurred in the SI-T3/V</li> </ul>
ERR	ON	Connection error	<ul style="list-style-type: none"> <li>SI-T3/V is not properly connected to the drive</li> <li>Communication error</li> </ul>
	Flashing	SI-T3/V error	Error found during SI-T3/V's self-diagnostic check
	OFF	Normal operation	<ul style="list-style-type: none"> <li>SI-T3/V is properly connected to the drive</li> <li>Communication normal</li> </ul>
TX	ON	Sending data	Data is being sent (LED may appear to be flashing)
	OFF	Not sending data	<ul style="list-style-type: none"> <li>No data is being sent</li> <li>During reset</li> </ul>
RX	ON	Receiving data	Data is being received (LED may appear to be flashing)
	OFF	Not receiving data	<ul style="list-style-type: none"> <li>No data is being received</li> <li>During reset</li> </ul>

## 5 Installation Procedure

### ◆ Section Safety

#### DANGER

##### Electrical Shock Hazard

**Do not connect or disconnect wiring while the power is on.**

Failure to comply will result in death or serious injury.

Disconnect all power to the drive, wait at least five minutes after all indicators are off, measure the DC bus voltage to confirm safe level, and check for unsafe voltages before servicing to prevent electric shock. The internal capacitor remains charged even after the power supply is turned off. The charge indicator LED will extinguish when the DC bus voltage is below 50 Vdc.

#### WARNING

##### Electrical Shock Hazard

**Do not remove option cover while the power is on.**

Failure to comply could result in death or serious injury.

The diagrams in this section may include option units and drives without covers or safety shields to show details. Be sure to reinstall covers or shields before operating any devices. The option should be used according to the instructions described in this manual.

**Do not allow unqualified personnel to use equipment.**

Failure to comply could result in death or serious injury.

Maintenance, inspection, and replacement of parts must be performed only by authorized personnel familiar with installation, adjustment, and maintenance of this product.

**Do not remove option cover while the power to the drive is on.**

Failure to comply could result in death or serious injury.

**Do not use damaged wires, place excessive stress on wiring, or damage the wire insulation.**

Failure to comply could result in death or serious injury.

**NOTICE**

**Damage to Equipment**

**Observe proper electrostatic discharge procedures (ESD) when handling the option unit, drive, and circuit boards.**

Failure to comply may result in ESD damage to circuitry.

**Never shut the power off when the drive is outputting voltage.**

Failure to comply may cause the application to operate incorrectly or damage the drive.

**Do not operate damaged equipment.**

Failure to comply may cause further damage to the equipment.

Do not connect or operate any equipment with visible damage or missing parts.

**Use only YASKAWA connection cables or recommended cables.**

Failure to comply may cause electrical interference resulting in poor system performance.

Use wires specified and ground the shield to the ground terminal of the drive.

**Properly connect all pins and connectors.**

Failure to comply may prevent proper operation and possibly damage equipment.

**Check wiring to ensure that all connections are correct after installing the option unit and connecting any other devices.**

Failure to comply may result in damage to the option unit.

◆ **Wiring Diagram**

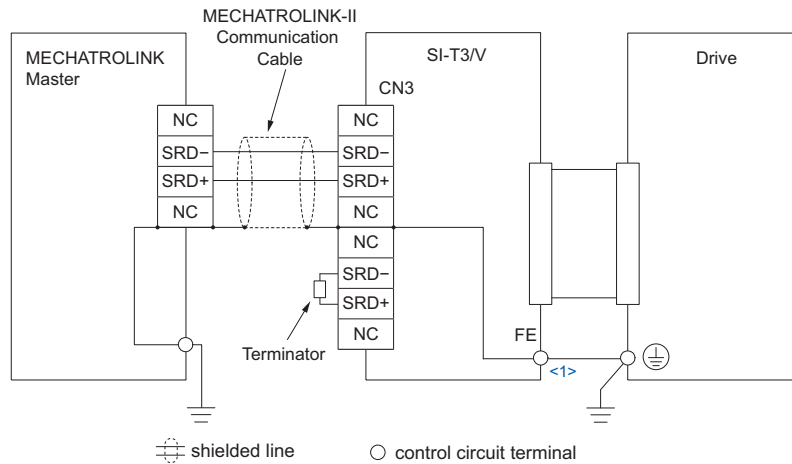

<1> The FE terminal on the MECHATROLINK-II Option is supplied with a ground cable that should be connected to the ground terminal on the drive.  
If there are noise influences on communication, remove the grounding cable.

**Figure 4 Wiring Diagram**

## ◆ Prior to Installing the Option Unit

Prior to installing the MECHATROLINK-II Option, wire the drive and make necessary connections to the drive terminals. Refer to the Quick Start Guide for information on wiring and connecting the drive. Verify that the drive functions normally prior to installing the Option.

## ◆ Installing the Option Unit

Remove the front cover of the drive before installing the MECHATROLINK-II Option. Follow the directions below for proper installation.

1. Switch off the power supply to the drive.

**DANGER! Electrical Shock Hazard** - Do not connect or disconnect wiring while the power is on. Failure to comply will result in death or serious injury. Before installing the MECHATROLINK-II Option, disconnect all power to the drive. The internal capacitor remains charged even after the power supply is turned off. The charge indicator LED will extinguish when the DC bus voltage is below 50 Vdc. To prevent electric shock, wait at least five minutes after all indicators are off and measure the DC bus voltage level to confirm safe level.

2. Remove the front cover. The original drive front cover may be discarded because it will be replaced by the MECHATROLINK-II Option cover in step 8.

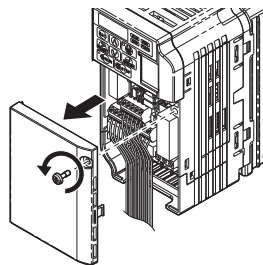

Figure 5 Remove Front Cover

3. Remove the bottom cover and connect the MECHATROLINK-II Option ground cable to the ground terminal.

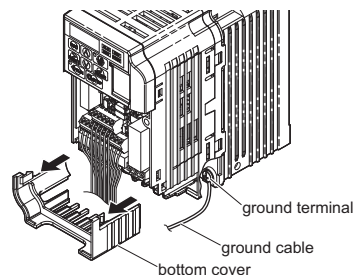
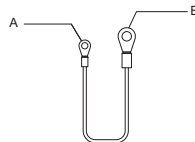

Figure 6 Connect Ground Cable

**Note:** The four different ground cables packaged with the MECHATROLINK-II Option connect the unit to different models. Select the proper ground cable from the MECHATROLINK-II Option kit depending on drive size.



- A – Option unit connection: screw size = M3
- B – Drive-side connection: screw size = M3.5 to M6

Figure 7 Ground Cable

## 5 Installation Procedure

**Note:** Remove the terminal cover </> before removing the bottom cover to install the MECHATROLINK-II Option. Replace the terminal cover after wiring the MECHATROLINK-II Option.

<1> **Models with a Terminal Cover:**

- Single-Phase 200 V Class: CIMR-V□BA0006 to BA0018
- Three-Phase 200 V Class: CIMR-V□2A0008 to 2A0069
- Three-Phase 400 V Class: All models

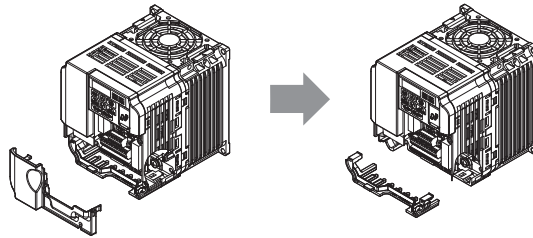

**Figure 8 Models with Terminal Cover**

4. Reattach the bottom cover.
5. Connect the MECHATROLINK-II Option to the drive. Properly secure the tabs on the left and right sides of the MECHATROLINK-II Option to the drive case.

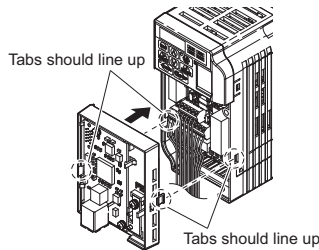

**Figure 9 Attach MECHATROLINK-II Option**

6. Connect the ground cable from the drive ground terminal to the MECHATROLINK-II Option ground. When wiring the MECHATROLINK-II Option, pass the ground cable through the inside of the drive bottom cover, then pass the ground cable into the through-hole at the front of the MECHATROLINK-II Option.

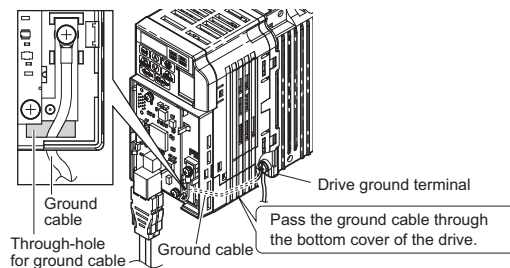

**Figure 10 Ground Cable Connection**

7. Connect the communications cable to the connector.
8. Attach the MECHATROLINK-II Option cover to the front of the MECHATROLINK-II Option.

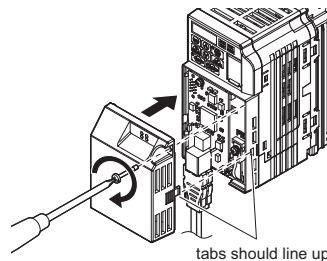

**Figure 11 Attach Cover**

**Note:** When using the drive in an area that may require displaying warning information in Japanese or Chinese, a sticker has been provided with the MECHATROLINK-II Option. This sticker can be placed over the English and French warnings on the front of the MECHATROLINK-II Option.



## ◆ MECHATROLINK-II Communications Cables

Wire the MECHATROLINK-II communications cables to the communications connector (CN3). Install MECHATROLINK-II communications cables apart from main-circuit wiring and other electrical and power lines.

**Note:** 1. For communications cables, use special shielded twisted-pair cables for MECHATROLINK communications.

Recommended cable: JEPMC-W6002-□□-E </>

JEPMC-W6003-□□-E (with a core) </>

2. Connect the terminator (model No.: JEPMC-W6022-E) on the end of the communication lines.

3. Maximum transmission distance is 50 m. Minimum wiring distance between stations is 0.5 m.

<1> □□ is the length (m).

## 6 MECHATROLINK Option Drive Parameters

Confirm proper setting of the all parameters in [Table 5](#) before starting network communications.

**Table 5 Parameter Settings**

No.	Name	Description	Default
<b>b1-01</b> <1>	Frequency Reference Selection	Selects the frequency reference input source. 0: Operator - Digital preset speed d1-01 to d1-17 1: Terminals - Analog input terminal A1 or A2 2: MEMOBUS Modbus communications 3: Option PCB 4: Pulse Input (Terminal RP)	1
<b>b1-02</b> <1>	Run Command Selection	Selects the run command input source. 0: Operator - RUN and STOP keys on the digital operator 1: Digital input terminals 2: MEMOBUS Modbus communications 3: Option PCB	1
<b>F6-01</b> <2>	Operation Selection after Communications Error	Determines drive response when a bUS error is detected during communications with the MECHATROLINK-II Option 0: Ramp to Stop 1: Coast to Stop 2: Fast-Stop 3: Alarm Only	1
<b>F6-02</b>	Selection of External Fault from Communication Option Board	0: Always detected 1: Detection during run only	0
<b>F6-03</b> <2>	Communication Option Fault Stopping Method	0: Ramp to stop. Decelerate to stop using the deceleration time in C1-02. 1: Coast to stop. 2: Fast Stop. Decelerate to stop using the deceleration time in C1-09. 3: Alarm only.	1
<b>F6-07</b>	NetRef/ComRef Function Selection	0: Multi-step reference disabled (same as F7) 1: Multi-step reference enabled (same as V7)	1
<b>F6-08</b>	Reset Communication Parameters	0: Communication-related parameters (F6-□□) are not reset when the drive is initialized using A1-02. 1: Reset all communication-related parameters (F6-□□) when the drive is initialized using A1-02.	0
<b>F6-20</b> <3> <4>	MECHATROLINK Station Address	20 to 3FH	21
<b>F6-21</b> <3>	MECHATROLINK Frame Size	0: 32 byte 1: 17 byte	0
<b>F6-22</b> <3>	MECHATROLINK Link Speed	0: 10 Mbps 1: 4 Mbps	0
<b>F6-23</b> <3> <5>	MECHATROLINK Monitor Selection (E)	0H to FFFFH	0
<b>F6-24</b> <3> <6>	MECHATROLINK Monitor Selection (F)	0H to FFFFH	0
<b>F6-25</b>	Operation Selection at Watchdog Timer Error (E5)	0: Ramp to stop. Decelerate to stop using the deceleration time in C1-02. 1: Coast to stop. 2: Fast Stop. Decelerate to stop using the deceleration time in C1-09. 3: Alarm only.	1
<b>F6-26</b>	MECHATROLINK bUS Errors Detected	Sets the number of option communication errors (bUS). 2 to 10	2

- <1> To start and stop the drive with the MECHATROLINK master device using serial communications, set b1-02 to 3. To control the frequency reference of the drive via the master device, set b1-01 to 3.
- <2> If set to 3, then the drive will continue to operate when a fault is detected. Take proper measures such as installing an emergency stop switch.
- <3> Power must be cycled in order for any setting changes to take affect.
- <4> All station addresses must be unique. If set to 20 or 3F, a Station Address Error (AEr) will occur and the ERR light will turn on.
- <5> Setting byte 10 of INV\_CTL to 0EH enables the register set by F6-23. Byte 11 and 12 of the response data enable the register content set by F6-23.
- <6> Setting byte 10 of INV\_CTL to 0FH enables the register set by F6-24. Byte 11 and 12 of the response data enable the register content set by F6-24.

## 7 Transmission Interface

### ◆ MECHATROLINK-II Cyclic Transmissions

As a MECHATROLINK-I/MECHATROLINK-II station, the SI-T3/V exchanges control data and I/O data with a control device, such as a controller. Communications with the master are executed by sending response data timed to the reception of command data for the local station address from the master in each transmission cycle. The formats for the command and response data follow the specifications for the MECHATROLINK Drive commands.

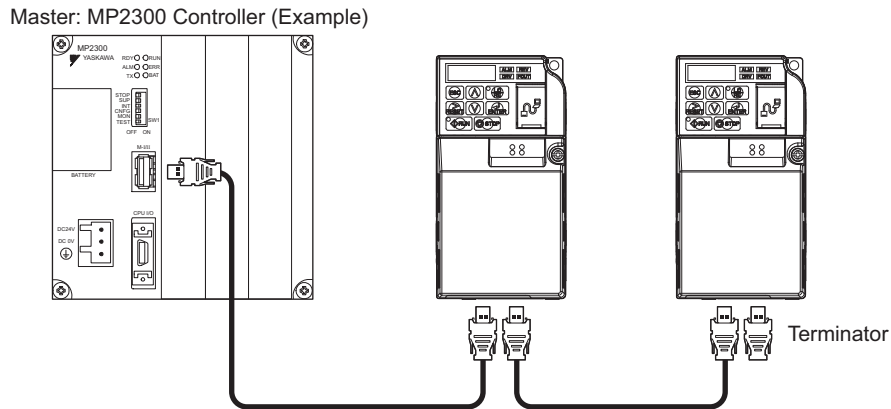

### ◆ Basic Format of Data Transfer

The basic format for transferring data is as follows.

The size of the header for a data link layer is fixed at two bytes.

By setting, either 17 bytes (17-byte data transmission) or 32 bytes (32-byte data transmission) can be selected as the data size for the data link layer. If 32-byte data transmission is selected, only the first 29 bytes <1> are used as application data.

<1> The first 30 bytes are used only when the INV\_I/O sub-command is used.

Command data		Response data		
+00H	Station address	+00H	Station address	Header of data link layer
+01H	Control code	+01H	Control code	
+02H	Command code	+02H	Response code	Data link layer data and application layer
+03H	—	+03H	Alarm	
+04H	Data	+04H	Status	
		+06H	Data	
+11H	WDT	+11H	EWDT	
+12H		+12H		

Figure 12 Basic format of data transfer (17-byte data transmission)

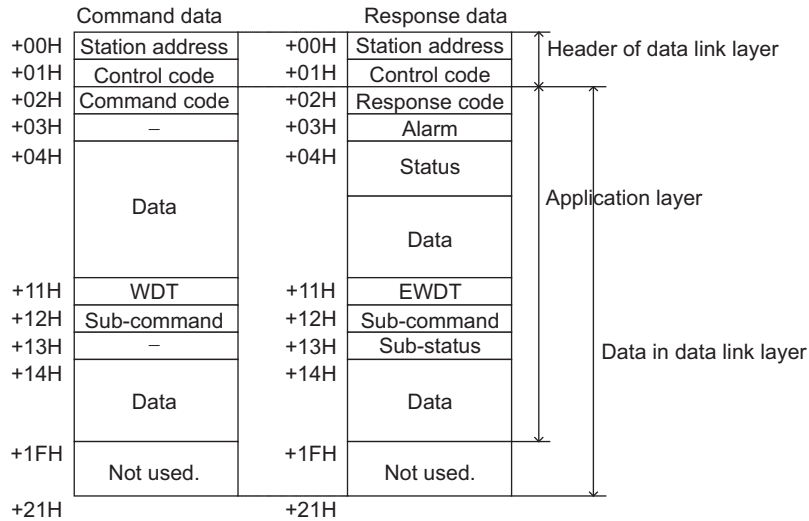

**Figure 13 Basic format of data transfer (32-byte data transmission)**

### ◆ Communications Phases

The SI-T3/V changes status as described here when a command code or fault is received from the master.

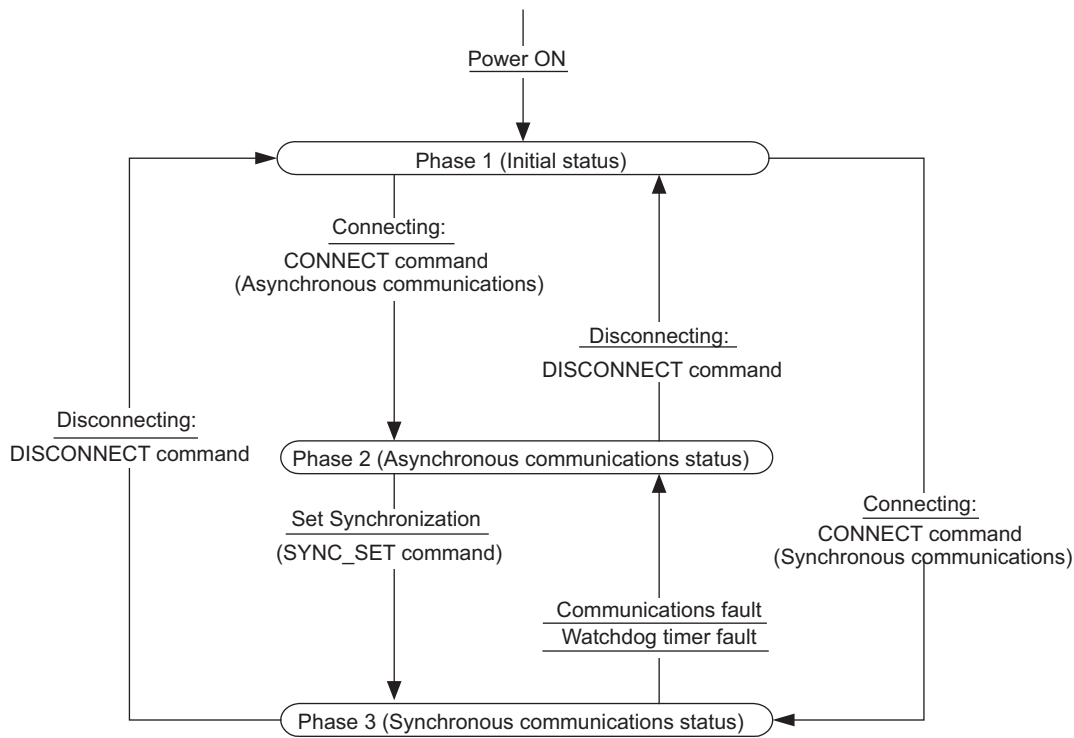

**Figure 14 Communication phases**

#### ■ Phase 1: Initial status after power ON

Operation proceeds with a default transmission cycle of 2 ms. The transmission cycle is changed to the time indicated in the synchronous frame when a CONNECT command is received from the master. Then the phase moves to phase 2 or phase 3 after a response to the CONNECT command is returned.

Even if a transfer fault is detected in phase 1, no fault notification is provided.

#### ■ Phase 2: Asynchronous communications

All SI-T3/V commands can be used. Phase 2 starts to count the watchdog timer in the communications frame. The phase moves to phase 3 when a SYNC\_SET command is received, and it moves to phase 1 when a DISCONNECT command is received.

### ■ Phase 3: Synchronous communications

Watchdog timer faults in the communications frame are detected. If the DISCONNECT command is received, the phase moves to phase 1. If a reception fault or a watchdog timer fault is detected, the phase moves to phase 2.

### ◆ Application Layer Specifications

The data format for the application layer conforms to the MECHATROLINK-II link command specifications.

SI-T3/V has the following main commands and sub-commands.

**Table 6 Main Commands**

Code	Name	Function
00H	NOP	No Operation
01H	PRM_RD	Read Parameter
02H	PRM_WR	Write Parameter
03H	ID_RD	Read ID Number
04H	CONFIG	RAM Write and EEPROM Write
05H	ALM_RD	Read Alarm and Warning
06H	ALM_CLR	Clear Alarm and Warning
0DH	SYNC_SET	Start Synchronous Communications
0EH	CONNECT	Connect
0FH	DISCONNECT	Disconnect
40H	INV_CTL	Drive Operation Control

**Table 7 Sub-commands**

Code	Name	Function
00H	NOP	No Operation
01H	PRM_RD	Read Parameter
02H	PRM_WR	Write Parameter
05H	ALM_RD	Read Alarm and Warning
41H	INV_I/O	Drive I/O Control

The main commands are used in both the 17-byte and 32-byte data transmissions for MECHATROLINK-II and with MECHATROLINK-I. The sub-commands can be used only when the 32-byte data transmission (F6-21 = 0) has been selected. If a conflict occurs between a request for a main command and a request for a sub-command, the request for the main command is processed. If either a main command or a sub-command is already being processed, the command being processed is given priority. If an INV\_CTL main command and an INV\_I/O sub-command conflict, the sub-command overwrites the main command.

For details on command formats, refer to [MECHATROLINK-II Commands on page 22](#).

The following table shows the combination of Main Commands and Sub-commands.

**Table 8 Main Command and Sub-command**

Code	Main Command	Sub-command				
		NOP (00)	PRM_RD (01)	PRM_WR (02)	ALM_RD (05)	INV_I/O (41)
00	NOP	OK	OK	OK	OK	OK
01	PRM_RD	OK	NG (A.95)	NG (A.95)	OK	OK
02	PRM_WR	OK	NG (A.95)	NG (A.95)	OK	OK
03	ID_RD	OK	OK	OK	OK	OK
04	CONFIG	OK	NG (A.95)	NG (A.95)	NG (A.95)	NG (A.95)
05	ALM_RD	OK	NG (A.95)	NG (A.95)	NG (A.95)	NG (A.95)
06	ALM_CLR	OK	NG (A.95)	NG (A.95)	NG (A.95)	NG (A.95)
0D	SYNC_SET	OK	OK	OK	OK	OK
0E	CONNECT	OK	NG (A.95)	NG (A.95)	NG (A.95)	NG (A.95)
0F	DISCONNECT	OK	NG (A.95)	NG (A.95)	NG (A.95)	NG (A.95)
40	INV_CTL	OK	OK	OK	OK	OK

## 8 MECHATROLINK-II Commands

### ◆ Main Commands

#### ■ NOP: 00H (No Operation)

Byte	Command	Response
1	NOP	NOP
2	0	ALARM
3, 4		STATUS
5 to 15		0
16		WDT

Only the ALARM and STATUS fields of the response data can be monitored. This command can be used in all phases.

#### ■ PRM\_RD: 01H (Read Parameter)

Byte	Command	Response
1	PRM_RD	PRM_RD
2	0	ALARM
3, 4		STATUS
5, 6		NO
7	SIZE	SIZE
8 to 15	0	PARAMETER
16	WDT	RWDT

The PRM\_RD command is used to read the Drive internal parameters. For offline parameters, it reads the most recently updated setting values. This command can be used in all phases.

In the following cases, a warning (STATUS (WARNING) = 1) is generated and the command is ignored. If a warning is generated, the values that are read are undefined.

- If a register number (NO) fault occurs: Data setting warning (A.94)
- If SIZE is an odd number or is not between 2 and 8: Data setting warning (A.94)

The register number (NO) is the same as the register number that is set and referenced in MEMOBUS transfers. Set the lower byte (LSB) before setting the upper byte (MSB). The SI-T3/V stores the data read for PARAMETER from lower byte (LSB) to upper byte (MSB). Refer to drive technical manual for detail.

For SIZE, set the number of bytes to be read as an even numbers. Eight bytes can be specified.

The values for the number (NO) and the size (SIZE) in the response are copies of the values in the command.

Example when reading C1-01 (200H):

**Table 9 Example when reading C1-01 (200H)**

Byte	Command	Response
5	00	00
6	02	02
7	02	02
8	00	Lower byte of C1-01
9	00	Upper byte of C1-01

### ■ PRM\_WR: 02H (Write Parameter)

Byte	Command	Response
1	PRM_WR	PRM_WR
2	0	ALARM
3, 4		STATUS
5, 6	NO	NO
7	SIZE	SIZE
8 to 15	DATA	DATA
16	WDT	RWDT

The PRM\_WR command is used to write the drive internal parameters.

To save the setting value in the drive EEPROM, set the CONFIG\_MOD in the CONFIG command to 1. For details, refer to the section describing the CONFIG command.

In the following cases, a warning is generated and the command is ignored.

- If a register number (NO) fault occurs: Data setting warning (A.94)
- If SIZE is an odd number or is not between 2 and 8: Data setting warning (A.94)
- Data upper/lower limit fault: Data setting warning (A.94)
- While using the Operator to change settings: Command warning (A.95)
- If not in phase 2 or 3: Command warning (A.95)
- During an undervoltage fault: Command warning (A.95)

The register number (NO) is the same as the register number that is set and referenced in MEMOBUS transfers.

Set the lower byte (LSB) before setting the upper byte (MSB). Refer to Drive Technical Manual for detail.

Set the values for DATA from lower byte (LSB) to upper byte (MSB). For SIZE, set the number of bytes to be written as an even number. Eight bytes can be specified.

The values for the NO, SIZE, and DATA in the response are copies of values in the command.

Example when writing in C1-01 (200H):

**Table 10 Example when writing in C1-01 (200H)**

Byte	Command	Response
5	00	00
6	02	02
7	02	02
8	Setting value (Lower byte)	Setting value (Lower byte)
9	Setting value (Upper byte)	Setting value (Upper byte)

### ■ ID\_RD: 03H (Read ID Number)

Byte	Command	Response
1	ID_RD	ID_RD
2	0	ALARM
3, 4		STATUS
5	DEVICE_CODE	DEVICE_CODE
6	OFFSET	OFFSET
7	SIZE	SIZE
8 to 15	0	ID
16	WDT	RWDT

The ID\_RD command is used to read the ID number.

The following table shows the applicable DEVICE\_CODE.

Because of ID area limitations, no more than eight bytes can be read, so use the OFFSET and SIZE to specify the range.

The leading ID data that corresponds to the specified OFFSET and returned is shown in the [Table 11](#) and [Table 12](#).

Up to eight bytes can be used for SIZE. This command can be used in all phases.

Table 11 DEVICE\_CODE

	DEVICE_CODE	ID content <1>															
	OFFSET	00	01	02	03	04	05	06	07	08	09	0A	0B	0C	0D	0E	0F
Drive Model	00H	C	I	M	R	-	V	<2>	<3>	<4>	0	0	0	6			
Software Version	02H			S	1	2	3	4		S	5	6	7	8			

- <1> The codes are expressed in ASCII, and end in 00H.
- <2> The portions showing the region are represented by spaces.
- <3> Indicates the voltage class. B: Single Phase 200 V, 2: Three Phase 200 V, 4: Three Phase 400 V
- <4> The portions showing the structure are represented by spaces.
- <5> Four digits indicating any customized specifications.
- <6> Indicates the SI-T3/V software code.
- <7> Indicates the Drive software code.

Table 12 Vender Code (DEVICE\_CODE = 0FH)

		ID content <1>															
Vender ID	OFFSET	0	01	02	03	04	05	06	07	08	09	0A	0B	0C	0D	0E	0F
		ASCII	0	8	1	0	0	0	0	00							
Vender Name	OFFSET	10	11	12	13	14	15	16	17	18	19	1A	1B	1C	1D	1E	1F
	ASCII	Y	A	S	K	A	W	A		E	L	E	C	T	R	I	C
	OFFSET	20	21	22	23	24	25	26	27	28	29	2A	2B	2C	2D	2E	2F
	ASCII		C	O	R	P	O	R	A	T	I	O	N	00			

<1> Vender IDs and vender names are expressed in ASCII, and end in 00H.

■ CONFIG: 04H (RAM Write and EEPROM Write)

Byte	Command	Response
1	CONFIG	CONFIG
2	0	ALARM
3, 4		STATUS
5	CONFIG_MOD	CONFIG_MOD
6 to 15	0	0
16	WDT	RWDT

The CONFIG command is used to enable the data for which parameters have been written.

Error codes such as matching of parameters cannot be checked by the responses to this command. They must be checked with the STATUS signal's oPE fault bit. This command can be used in phases 2 and 3.

In the following cases, a warning is generated and the command is ignored.

- If CONFIG\_MOD is not a set value: Data setting warning (A.94)
- If not in phase 2 or 3: Command warning (A.95)

The following values can be assigned to CONFIG\_MOD.

Table 13 CONFIG\_MOD

CONFIG_MOD	Description
0	Write RAM The setting value is not saved in EEPROM.
1	The setting value is saved in EEPROM. Note: With the V1000, the maximum number of writes to non-volatile memory is 100,000, so do not use the CONFIG command too frequently. If changing several parameters, carry out the CONFIG command only after all the parameters have been changed.



## ■ ALM\_RD: 05H (Read Alarm and Warning)

Byte	Command	Response
1	ALM_RD	ALM_RD
2	0	ALARM
3, 4		STATUS
5	ALM_RD_MOD	ALM_RD_MOD
6 to 15	0	ALM_DATA
16	WDT	RWDT

Table 14 ALM\_RD\_MOD

Byte	ALM_RD_MOD = 0	ALM_RD_MOD = 1	ALM_RD_MOD = 2
5	00H	01H	02H
6	U2-01	U3-01	Alarm Index
7	U2-02	U3-02	Lower byte of U3-(Alarm Index + 1)
8		U3-03	Upper byte of U3-(Alarm Index + 1)
9		U3-04	
10		U3-05	
11		U3-06	
12		U3-07	
13		U3-08	
14		U3-09	
15		U3-10	

The ALM\_RD command is used to read the following information about the status of faults and alarms.

- Present fault and alarm status list
- Fault history (Alarms are not saved in the history.)
- Details of faults

In the following case, a warning is generated and the command is ignored.

- If ALM\_RD\_MOD is other than a set value: Data setting warning (A.94)

The fault history is saved in EEPROM and is kept even when the control power is interrupted.

- If ALM\_RD\_MOD is set to 0: Fault code (1 byte) is entered to byte 6 of ALM\_DATA, and byte 7 becomes the value of the previous fault.
- If ALM\_RD\_MOD is set to 1: Fault code is entered in order of detection from ALM\_DATA byte 6 so that byte 6 is the most recent fault.
- When ALM\_RD\_MOD is set to 2: Fault code detected by the value set by the Alarm Index +1 is entered to bytes 7 and 8.

During normal operation (i.e., when no fault has occurred), the value is 00H.

Table 15 ALM\_DATA

ALM_RD_MOD	ALM_DATA	Max. Processing Time	Parameter No.
0	Present fault (byte 6), past fault (byte 7)	0.1 s	U2-01 and U2-02
1	Fault history trace 10 max. (byte 6 to 15)	0.1 s	U3-01 to U3-10
2	Fault history (Alarms are not retained in the history.) (bytes 7 and 8)	0.1 s	U3-01 to U3-10

■ **ALM\_CLR: 06H (Clear Alarm and Warning)**

Byte	Command	Response
1	ALM_CLR	ALM_CLR
2	0	ALARM
3, 4		STATUS
5	ALM_CLR_MOD	ALM_CLR_MOD
6 to 15	0	0
16	WDT	RWDT

The ALM\_CLR command is used to clear the alarm and warning status.

This command changes the status of the station. It does not remove the cause of a fault. After the cause of the alarm or warning has been removed, this command is then used to clear the status of the alarm or warning.

In the following cases, a warning is generated and the command is ignored.

- If not in phase 2 or 3: Command warning (A.95)
- If ALM\_CLR\_MOD is other than a set value: Data setting warning (A.94)

**Table 16 ALM\_CLR\_MOD**

ALM_CLR_MOD	Description
0	Clears the status of present faults and alarms.

**Note:** Drive alarms cannot be reset while the Drive RUN command is ON.

■ **SYNC\_SET: 0DH (Start Synchronous Communications)**

Byte	Command	Response
1	SYNC_SET	SYNC_SET
2	0	ALARM
3, 4		STATUS
5 to 15	WDT	0
16		RWDT

The SYNC\_SET command is used to request the start of synchronous communications. After this command is issued, synchronous communications are carried out. If communications become asynchronous due to any fault such as a communications fault, this command can be used to restore synchronous communications.

In the following case, a warning is generated and the command is ignored.

- If not in phase 2 or 3: Command warning (A.95)

■ **CONNECT: 0EH (Connect)**

Byte	Command	Response
1	CONNECT	CONNECT
2	0	ALARM
3, 4		STATUS
5	VER	VER
6	COM_MOD	COM_MOD
7	COM_TIM	COM_TIM
8 to 15	0	0
16	WDT	RWDT

The CONNECT command is used to set the communications mode and establish a connection. After the connection is established, the phase moves to phase 2 or 3.

If a transfer fault is detected after moving to phase 2 or phase 3, notification is given of the fault. In phase 1, no notification is given even if a transfer fault is detected. Set VER (version) to 21H (Ver. 2.1) for MECHATROLINK-II, and to 10H (Ver. 1.0) for MECHATROLINK-I.

The communications mode is set by the COM\_MOD. For details on the settings, refer to the following description.

**MECHATROLINK-II (VER: 21H)****COM\_MOD**

D7	D6	D5	D4	D3	D2	D1	D0
SUBCMD	0	0	0	DTMOD		SYNCMOD	0

SUBCMD	Sub-command setting	0	Sub-command not used
		1	Sub-command used
DTMOD	Communication Mode	00	Single data transfer mode
		01/10/11	Data setting alarm (A.94)
SYNCMOD	Transmission Synchronization	0	Move to phase 2
		1	Move to phase 3

**Note:** If D6, D5, D4, or D0 is set to 1, a warning will be generated (Data setting warning: A.94).

**COM\_TIM**

Set the factor of the transmission cycle to COM\_TIM (communications time) so that the setting range satisfies the following formulas.

**When the transmission cycle is equal to the communications time (COM\_TIM = 1):**

- 32-byte data transmission  
 $1 \text{ [ms]} \leq \text{transmission cycle [ms]} \leq 8 \text{ [ms]}$   
 If the transmission cycle is set to a fractional value, a warning (Data setting warning: A.94) is generated.
- 17-byte data transmission  
 $0.5 \text{ [ms]} \leq \text{transmission cycle [ms]} \leq 8 \text{ [ms]}$   
 If the transmission cycle is not set to a multiple of 0.5 ms, such as 0.75, a warning (Data setting warning: A.94) is generated.

**When the transmission cycle is not equal to the communications time (1 < COM\_TIM ≤ 32):**

$$2 \text{ [ms]} \leq \text{transmission cycle [ms]} \times \text{COM\_TIM} \leq 100 \text{ [ms]}$$

If the transmission cycle is less than 2 ms and is set to a fractional value, a warning (Data setting warning: A.94) is generated. If the communications cycle is set to a fractional value, a warning (Data setting warning: A.94) is generated.

**MECHATROLINK-I (VER: 10H)****COM\_MOD**

D7	D6	D5	D4	D3	D2	D1	D0
0	0	0	0	DTMOD		SYNCMOD	EXMOD

DTMOD	Communication Mode	00	Single data transfer mode
		01/10/11	Data setting alarm (A.94)
SYNCMOD	Transmission Synchronization	0	Move to phase 2
		1	Move to phase 3
EXMOD	Request to establish expanded/standard connection	0	Standard connection
		1	Expanded connection Even if SYNCMOD = 1 (synchronous comm.), SYNCMOD will be set to 0 for asynchronous data transmission.

In the following cases, a warning is generated and the command is ignored. Commands are also ignored in phase 2 (with no alarm).

- If COM\_MOD is set out of range: Data setting warning (A.94)
- If SUBCMD is set to 1 in 17-byte data transmission: Data setting warning (A.94)
- If SUBCMD is set to 1 for Ver. 1.0 (VER: 10H): Data setting warning (A.94)
- If D6, D5, D4, D3, or D0 is set to 1: Data setting warning (A.94)

### COM\_TIM

In MECHATROLINK-I, COM\_TIM was set in multiples of two because the units for COM\_TIM were 1 = 1 ms and transmission cycles were fixed at 2 ms.

$$2 [\text{ms}] \leq \text{COM\_TIM} \leq 64 [\text{ms}]$$

When transferring data in 2 ms cycles, set COM\_TIM = 2. To use 4 ms cycles, set COM\_TIM = 4.

In the following cases, a warning is generated and the command is ignored. Commands are also ignored in phase 2 (with no alarm).

- If COM\_TIM is set out of range: Data setting warning (A.94)

### ■ DISCONNECT: 0FH (Disconnect)

Byte	Command	Response
1	DISCONNECT	DISCONNECT
2	0	ALARM
3, 4		STATUS
5 to 15		
16	WDT	RWDT

The DISCONNECT command is used to close the connection and move to phase 1.

After moving to phase 1, no check for transmission faults is executed. This command can be used in phases 2 and 3.

If this command is received while in phase 2 or 3, the data for the control command to the Drive is cleared to 0, and a fault reset command is carried out for the Drive.

### ■ INV\_CTL: 40H (Drive Operation Control)

Byte	Command	Response
1	INV_CTL	INV_CTL
2	0	ALARM
3, 4	Operation signals	STATUS
5, 6	Speed reference	Output frequency
7, 8	Reserved	Output current
9	SEL REF1/2	SEL REF1/2
10	SEL MON1/2	SEL MON1/2
11, 12	Reference selected by SEL REF1	Monitor selected by SEL MON1
13, 14	Reference selected by SEL REF2	Monitor selected by SEL MON2
15	0	0
16	WDT	RWDT

The INV\_CTL command is used to set the drive operation signals, speed references, and so on.

These bytes do not need to be set every scan. The settings are saved in the drive until the next data is received or until the power is turned OFF. For details on operation signals, refer to [Table 17](#).

The speed reference and the output frequency units can be selected with o1-03.

Table 17 Operation Signals

Bit	Name	Description	Remarks
0	Forward run	0: Stop 1: Forward run	
1	Reverse run	0: Stop 1: Reverse run	
2	Multi-function terminal input 3	Terminal S3 input function 0: Terminal S3 function OFF 1: Terminal S3 function ON	H1-03 (Default = 24: External fault (EF3))
3	Multi-function terminal input 4	Terminal S4 input function 0: Terminal S4 function OFF 1: Terminal S4 function ON	H1-04 (Default = 14: Fault reset)
4	Multi-function terminal input 5	Terminal S5 input function 0: Terminal S5 function OFF 1: Terminal S5 function ON	H1-05 (Default = 3: Multi-step speed reference 1)
5	Multi-function terminal input 6	Terminal S6 input function 0: Terminal S6 function OFF 1: Terminal S6 function ON	H1-06 (Default = 4: Multi-step speed reference 2)
6	Multi-function terminal input 7 <1>	Terminal S7 input function 0: Terminal S7 function OFF 1: Terminal S7 function ON	H1-07 (Default = 6: Jog command)
7	Reserved		
8	External fault (EF0)	1: External fault (EF0)	
9	Fault reset <2> <3>	1: Fault reset	
A to D	Reserved		
E	Fault history trace clear	1: Fault history trace clear	
F	External BB command	1: External BB command ON	

<1> CIMR-VC□□□□□□ drives do not have terminal S7.

<2> Check that the faults has been successfully reset by confirming that the STATUS (RESET) bit has turned OFF.

<3> Errors are not reported while the fault reset signal is ON.

Use the SEL REF1/2 command to select the contents of REF1 with bits 0 to 3 and to select the contents of REF2 with bits 4 to 7.

Use the SEL MON1/2 command to select the contents of MON1 with bits 0 to 3 and to select the contents of MON2 with bits 4 to 7.

Table 18 and Table 19 show the selection ranges for SEL REF1/2 and SEL MON1/2.

Table 18 SEL REF1/2 Selection Range

REF1/2	Item	Remarks
0	Nothing selected	
1	Reserved	
2	Analog output terminal 1 output	Enable when H4-01=0
3	Reserved	
4	Drive terminal output Bit: terminal MA-MC Bit: terminal P1 Bit2: terminal P2	terminal MA-MC (Enable when H2-01=F) terminal P1 (Enable when H2-02=F) terminal P2 (Enable when H2-03=F)
5	PID set point	Unite: 0.01%
6	Pulse train output	Unite: 1 Hz
7	V/f gain	
8	Reserved	
9	Command selection bit1: PID set point value enable	
A to F	Not used.	

Table 19 SEL MON1/2 Selection Range

MON1/2	Item	Remarks
0	Nothing selected	
1	Motor Speed	Determined by U1-05 and o1-03
2	Torque reference (Monitor)	U1-09, 0.1%
3	Reserved	
4	Frequency reference	Determined by U1-01, o1-03
5	Analog input A2	U1-14, 0.1%
6	Main circuit current voltage	U1-07, 1V
7	Drive alarm	Refer to Drive Alarm Code
8	Drive warning	Refer to Drive Warning Code
9	Multi-function output terminal status	U1-11
A	Reserved	
B	Multi-function input terminal S1 to S7 <1>	U1-10
C	Analog input A1	U1-13, 0.1%
D	Reserved	
E	Monitor data set in F6-23	
F	Monitor data set in F6-24	

<1> CIMR-VC□□□□□□ drives do not have terminal S7.

In the following case, a warning is generated and the command is ignored.

- If not in phase 2 or 3: Command warning (A.95)

### ◆ Sub-commands

Sub-commands can be used only with MECHATROLINK-II when the 32-byte data transmission (F6-21 = 0) has been selected.

#### ■ NOP: 00H (No Operation)

Byte	Command	Response
17	NOP	NOP
18	0	SUBSTATUS
19 to 29		0

This is the format of No Operation sub-command.

#### ■ PRM\_RD: 01H (Read Parameter)

Byte	Command	Response
17	PRM_RD	PRM_RD
18	0	SUBSTATUS
19, 20	NO	NO
21	SIZE	SIZE
22 to 29	0	PARAMETER

The PRM\_RD sub-command is used to read internal Drive parameters. This sub-command functions in the same way as the PRM\_RD main command.

In the following cases, a warning is generated and the command is ignored. If a warning is generated, the values that were read are undefined.

- If a register number (NO) fault occurs: Data setting warning (A.94)
- If SIZE is an odd number or is not between 2 and 8: Data setting warning (A.94)
- If a main command is PRM\_RD or PRM\_WR: Command warning (A.95)

### ■ PRM\_WR: 02H (Write Parameter)

Byte	Command	Response
17	PRM_WR	PRM_WR
18	0	SUBSTATUS
19, 20	NO	NO
21	SIZE	SIZE
22 to 29	PARAMETER	PARAMETER

The PRM\_WR sub-command is used to write internal Drive parameters. This sub-command functions in the same way as the PRM\_WR main command.

In the following cases, a warning is generated and the command is ignored. If a warning is generated, the values that were read are undefined.

- If a register number (NO) fault occurs: Data setting warning (A.94)
- If SIZE is an odd number or is not between 2 and 8: Data setting warning (A.94)
- Data upper and lower limit fault: Data setting warning (A.94)
- During an undervoltage error: Command warning (A.95)
- If a main command is PRM\_RD or PRM\_WR: Command warning (A.95)
- While using the operator to change settings: Command warning (A.95)
- If not in phase 2 or 3: Command warning (A.95)

### ■ ALM\_RD: 05H (Read Alarm and Warning)

Byte	Command	Response
17	ALM_RD	ALM_RD
18	0	SUBSTATUS
19	ALM_RD_MOD	ALM_RD_MOD
20 to 29	0	ALM_DATA

The ALM\_RD sub-command is used to read the fault and alarm status. This sub-command functions in the same way as the ALM\_RD main command.

In the following case, a warning is generated and the command is ignored.

- If ALM\_RD\_MOD is not set: Data setting warning (A.94)

### ■ INV\_I/O: 41H (Drive I/O Control)

Byte	Sub-Command	Response
17	INV_I/O	INV_I/O
18	0	SUBSTATUS
19	SEL REF3/4	SEL REF3/4
20	SEL REF5/6	SEL REF5/6
21	SEL MON3/4	SEL MON3/4
22	SEL MON5/6	SEL MON5/6
23, 24	Reference selected by SEL REF3	Monitor selected by SEL MON3
25, 26	Reference selected by SEL REF4	Monitor selected by SEL MON4
27, 28	Reference selected by SEL REF5	Monitor selected by SEL MON5
29, 30	Reference selected by SEL REF6	Monitor selected by SEL MON6

The INV\_I/O sub-command is used to select the type of output from the Drive's terminals and refers to the values from the Drive's internal monitors.

These settings do not need to be set every scan. The settings are saved in the Drive until the next data is received or until the power is turned OFF.

## 8 MECHATROLINK-II Commands

The SEL REF3/4 sub-command is used to select the contents of REF3 with bits 0 to 3, and select the contents of REF4 with bits 4 to 7.

The SEL REF5/6 sub-command is used to select the contents of REF5 with bits 0 to 3, and select the contents of REF6 with bits 4 to 7.

Refer to [Table 18](#) for detail on the selection range for SEL REF 3 to 6.

The SEL MON3/4 sub-command is used to select the contents of MON3 with bits 0 to 3, and select the contents of MON4 with bits 4 to 7.

The SEL MON5/6 sub-command is used to select the contents of MON5 with bits 0 to 3, and select the contents of MON6 with bits 4 to 7.

Refer to [Table 19](#) for detail on the selection range for SEL MON 3 to 6.

In the following cases, a warning is generated and the command is ignored.

- If not in phase 2 or 3: Command warning (A.95)

### ◆ Status

This section describes the STATUS field for main commands and the SUBSTATUS field for sub-commands.

#### ■ STATUS Field

Bit	Name	Description	Value	Setting
0	ALM	Alarm (fault) status	0	No alarm
			1	Alarm (fault)
1	WARNG	Warning status	0	No warning
			1	Warning
2	CMDRDY	Command ready	0	Busy
			1	Ready
3	BB OFF	Baseblock OFF (OFF when output voltage is being output from the drive or during baseblock.)	0	Baseblock ON
			1	Baseblock OFF
4	PON	Main power supply ON (OFF during undervoltage)	0	Main power supply OFF
			1	Main power supply ON
5	RUNX	Running	0	–
			1	Running
6	0SP	Zero speed	0	–
			1	Zero speed
7	REV	Reverse RUN	0	Forward RUN
			1	Reverse RUN
8	RESET	Fault reset signal input	0	–
			1	Fault reset signal input
9	AGREE	Speed agreement	0	–
			1	Speed agreement
A	INV_READY	Drive ready	0	–
			1	Drive ready
B	OPE	oPE fault	0	–
			1	oPE fault
C	UV_R	Recovery after power loss or recovery after momentary power loss	0	Recovery after power loss
			1	Recovery after momentary power loss
D	REMOTE	Local or Remote	0	Local
			1	Remote (Transfer)
E	SEL_M	Motor Selection	0	Motor 1
			1	Motor 2
F	–	Reserved	0	–
			1	–

**Note:** With the PRM\_RD command, only the settings for the STATUS (CMDRDY) is valid. Other bits are not used.



## ■ SUBSTATUS Field

D7	D6	D5	D4	D3	D2	D1	D0
–	–	–	–	–	SUBCMDRDY	SUBWARNG	SUBALM

Bit	Name	Description	Value	Setting
0	SUBALM	Sub-command alarm	0	No alarm
			1	Alarm
1	SUBWARNG	Sub-command warning	0	No warning
			1	Warning
2	SUBCMDRDY	Sub-command ready (Sub-command can be received.)	0	Busy
			1	Ready

**Note:** Bit 3 to 7 are not used. A value of 0 is always returned.

## 9 Troubleshooting

### ◆ Fault Detection Processing

Faults can be detected by two methods: Drive fault detection and SI-T3/V fault detection.

The SI-T3/V is notified of drive faults by the internal interface, and the SI-T3/V sends the response data, ALARM or STATUS.

The SI-T3/V notifies drive of SI-T3/V faults by the internal interface, and the faults are simultaneously sent the response data, ALARM or STATUS.

The following four types of faults can be detected. The subsequent operation varies depending on the type of fault.

**Table 20 Fault Type**

Fault Type		Location	Description
Alarm	Drive alarm	Drive	Major fault that causes damage to the drive or machinery
	Communications alarm	SI-T3/V	Interference related to MECHATROLINK-II communications
Warning	Drive warning	Drive	Illegal operation or minor fault not posing any immediate danger
	Communications warning	SI-T3/V	MECHATROLINK-II communications fault warning

**Table 21 Fault Type and SI-T3/V Processing**

Fault Type	SI-T3/V Processing				Processing	Direction of Communications	Reset
	MECHATROLINK Response			LED (ERR)			
	ALARM	STATUS					
		WARNG	ALM				
Drive alarm	CODE	–	1	–	No special processing	←	Required
Communications alarm	CODE	–	1	ON	Notification to drive	←	Required
Drive warning	CODE	1	–	–	No special processing	←	Required
Communications warning	CODE	1	–	–	No special processing	None	Not required

**Note:**The meanings of each symbol are as follows.

– : No change

← : Fault notification from Drive

When consecutive alarms occur, the SI-T3/V provides notification of the most recent alarm with a MECHATROLINK response data. If warnings occur simultaneously, notification priority is given to the warning with the lowest warning code. If alarms and warnings are mixed together, the SI-T3/V gives notification priority to alarms.

The [Table 22](#) shows the response data when consecutive alarms or warnings occurs.

**Table 22 Response Data for Consecutive Alarms and/or Warnings**

Fault Detection		MECHATROLINK-II Response Data Contents		
Previous Value	Most Recent Value	Alarm	STATUS	
			WARNG	ALM
Alarm	Alarm	Most recent alarm code	0	1
Alarm	Warning	Most recent alarm code	1	1
Warning	Alarm	Most recent alarm code	1	1
Warning	Warning	Warning with the smaller warning code	1	0

## ◆ Alarm Processing

### ■ SI-T3/V Communications Fault Detection

The following tables show the communications faults detected by the SI-T3/V and the conditions in which they can be detected.

**Table 23 Reception Failures in Each Phase**

Communications Phase	Reception Failure		Transmission cycle
	First	Second (Consecutive)	Fault
Phase 1	–	–	–
Phase 2	96	E6	E6
Phase 3	96	E6	E6

**Table 24 Alarm Code (MECHATROLINK-II Response ALARM Value)**

ALARM	Description	Fault Type
96	MECHATROLINK-II communications fault warning	Communications warning
E5	MECHATROLINK-II WDT fault	Communications alarm
E6	MECHATROLINK-II communications fault	Communications alarm

**Table 25 Fault Types**

Fault	Description
Communications failure	Transmission LSI detected a data reception failure.
Transmission cycle fault	A timing fault of a synchronous frame in a transmission cycle was detected.
Watchdog timer fault	A WDT count fault in a synchronous frame was detected.

### ■ Other Faults

The following table shows other faults that can be detected by the SI-T3/V. If a warning occurs, operation will follow the previous command.

**Table 26 Other fault detected by SI-T3/V**

ALARM	Description	Fault Type	Operation when Fault Occurs
94	Data setting warning	Communications warning	Received commands are ignored.
95	Command warning	Communications warning	Received commands are ignored.
EC	WDC fault with drive	Communications alarm	Waits for power supply to be reset.
ED	Drive access permission fault (Access not possible 10 consecutive times)	Communications alarm	Waits for power supply to be reset.
EE	Drive monitor timer over (1 s elapsed)	Communications alarm	Waits for power supply to be reset. Received commands are ignored. <I>

<I> If the ERR indicator is not lit or flashing, any commands that are received will be ignored.

### ■ Drive Fault Notification

If a fault is detected in the drive, the MECHATROLINK-II option stores the alarm or warning code in the MECHATROLINK-II ALARM command and simultaneously turns ON the relevant bit in the STATUS field.

The following tables show the alarm codes for MECHATROLINK-II option notification if a fault is detected in the drive.

**Table 27 Drive Alarm Codes**

ALRM Code (Hex)	Display		Description
02	<i>Uu1</i>	Uv1	Undervoltage
03	<i>Uu2</i>	Uv2	Control Power Supply Undervoltage
04	<i>Uu3</i>	Uv3	Soft Charge Circuit Fault
06	<i>GF</i>	GF	Ground Fault
07	<i>oC</i>	oC	Overcurrent
08	<i>ou</i>	ov	Overvoltage
09	<i>oH</i>	oH	Heatsink Overheat
0A	<i>oH1</i>	oH1	Heatsink Overheat
0B	<i>oL1</i>	oL1	Motor Overload
0C	<i>oL2</i>	oL2	Drive Overload
0D	<i>oL3</i>	oL3	Overtorque Detection 1
0E	<i>oL4</i>	oL4	Overtorque Detection 2
0F	<i>rr</i>	rr	Dynamic Braking Transistor
10	<i>rH</i>	rH	Dynamic Braking Resistor
11	<i>EF3</i>	EF3	External Fault (input terminal S3)
12	<i>EF4</i>	EF4	External Fault (input terminal S4)
13	<i>EF5</i>	EF5	External Fault (input terminal S5)
14	<i>EF6</i>	EF6	External Fault (input terminal S6)
15	<i>EF7</i>	EF7	External Fault (input terminal S7)
18	<i>oS</i>	oS	Overspeed (for Simple V/f with PG)
19	<i>dEv</i>	dEv	Excessive Speed Deviation (for Simple V/f with PG)
1A	<i>PGo</i>	PGo	PG Disconnect (for Simple V/f with PG)
1B	<i>PF</i>	PF	Input Phase Loss
1C	<i>LF</i>	LF	Output Phase Loss
1D	<i>oH3</i>	oH3	Motor Overheat 1 (PTC input)
1E	<i>oPr</i>	oPr	Operator Connection Fault
1F	<i>Err</i>	Err	Operator error
20	<i>oH4</i>	oH4	Motor Overheat 2 (PTC input)
22	<i>bUS</i>	bUS	Option Communication Error
25	<i>CF</i>	CF	Control Fault
27	<i>EF0</i>	EF0	Option Card External Fault
28	<i>FbL</i>	FbL	Feedback Loss
29	<i>UL3</i>	UL3	Undertorque Detection 1
2A	<i>UL4</i>	UL4	Undertorque Detection 2
2B	<i>oL7</i>	oL7	High Slip Braking oL
36	<i>LF2</i>	LF2	Output current imbalance
37	<i>STo</i>	STo	Motor Pull Out or Step Out Detection
39	<i>E5</i>	E5	SI-T3 Watchdog Timer Error
3B	<i>SEr</i>	SEr	Too Many Speed Search Restarts
41	<i>FbH</i>	FbH	Excessive PID Feedback
42	<i>EF1</i>	EF1	External Fault (input terminal S1)

ALRM Code (Hex)	Display		Description
43	EF2	EF2	External Fault (input terminal S2)
44	oL5	oL5	Mechanical Weakening Detection 1
45	UL5	UL5	Mechanical Weakening Detection 2
46	CoF	CoF	Current Offset Fault
49	dWFL	dWFL	DriveWorksEZ Fault
83	CPF02	CPF02	A/D Conversion Error
84	CPF03	CPF03	PWM Data Fault
87	CPF06	CPF06	Drive specification mismatch during Terminal Board or Control Board replacement
88	CPF07	CPF07	Terminal Board Communication Fault
89	CPF08	CPF08	EEPROM Serial Communications Fault
8C	CPF11	CPF11	RAM Fault
8D	CPF12	CPF12	FLASH Memory Fault
8E	CPF13	CPF13	Watchdog Circuit Exception
8F	CPF14	CPF14	Control Circuit Fault
91	CPF16	CPF16	Clock Fault
92	CPF17	CPF17	Timing Fault
93	CPF18	CPF18	Control Circuit Fault
94	CPF19	CPF19	Control Circuit Fault
95	CPF20 or CPF21	CPF20 or CPF21	RAM fault
96			FLASH memory error (ROM error)
96			Watchdog circuit exception (self-diagnostic error)
96			Clock error
97	CPF22	CPF22	A/D Conversion Error
98	CPF23	CPF23	PWM Feedback Data Fault
99	CPF24	CPF24	Drive Capacity Signal Fault
FA	oFA00 to oFA43	oFA00 to oFA43	Option Unit Fault

Table 28 Drive Minor Fault and Alarm

ALRM Code (Hex)	Display		Description
01	Uu	Uv	Undervoltage
02	ou	ov	Overvoltage
03	oH	oH	Heatsink Overheat
04	oH1	oH1	Drive Overheat
05	oL3	oL3	Overtorque 1
06	oL4	oL4	Overtorque 2
07	EF	EF	Run Command Input Error
08	bb	bb	Drive Baseblock
09	EF3	EF3	External Fault (input terminal S3)
0A	EF4	EF4	External Fault (input terminal S4)
0B	EF5	EF5	External Fault (input terminal S5)
0C	EF6	EF6	External Fault (input terminal S6)
0D	EF7	EF7	External Fault (input terminal S7)
10	oS	oS	Overspeed (for Simple V/f with PG)
11	dEv	dEv	Excessive Speed Deviation (for Simple V/f with PG)
12	PGo	PGo	PG Disconnect (for Simple V/f with PG)
15	bUS	bUS	Option Communication Error

## 9 Troubleshooting

ALRM Code (Hex)	Display		Description
16	<i>CALL</i>	CALL	Serial Communication Transmission Error
1A	<i>EF0</i>	EF0	External fault detected for communications board other than SI-K2
1B	<i>rUn</i>	rUn	Motor Switch during Run
1E	<i>UL3</i>	UL3	Undertorque 1
1F	<i>UL4</i>	UL4	Undertorque 2
20	<i>SE</i>	SE	MEMOBUS/Modbus Communication Test Mode Error
22	<i>oH3</i>	oH3	Motor Overheat
27	<i>FbL</i>	FbL	PID Feedback Loss
28	<i>FbH</i>	FbH	Excessive PID Feedback
2A	<i>dnE</i>	dnE	Drive Disabled
31	<i>E5</i>	E5	SI-T3 Watchdog Timer Error
33	<i>CyC</i>	CyC	SI-T3 Transmission Cycle Error
34	<i>HCA</i>	HCA	Current Alarm
39	<i>EF1</i>	EF1	External Fault (input terminal S1)
3A	<i>EF2</i>	EF2	External Fault (input terminal S2)
3B	<i>HbbF</i>	HbbF	Safe Disable Signal Input
3C	<i>Hbb</i>	Hbb	Safe Disable Signal Input
3D	<i>oL5</i>	oL5	Mechanical Weakening Detection 1
3E	<i>UL5</i>	UL5	Mechanical Weakening Detection 2
49	<i>dWAL</i>	dWAL	DriveWorksEZ Program Error Output
-	<i>CrST</i>	CrST	Can Not Reset

## ◆ Drive-Side Error Codes

Drive-side error codes appear on the drive's LED operator. Causes of the errors and corrective actions are listed in [Table 29](#).

For additional error codes that may appear on the LED operator screen, refer to the V1000 Technical Manual.

### ■ Faults

Both bUS (MECHATROLINK-II Option Communication Error), EF0 (External Fault Input from the MECHATROLINK-II Option) and E5 (SI-T3 Watchdog Timer Error) can appear as an alarm or as a fault. When a fault occurs, the digital operator ALM LED remains. When an alarm occurs, the digital operator ALM LED flashes.

If communication stops while the drive is running, answer the following questions to help remedy the fault:

- Is the MECHATROLINK-II Option properly installed?
- Is the communication line properly connected to the MECHATROLINK-II Option? Is it loose?
- Is the PLC program working? Has the PLC CPU stopped?
- Did a momentary power loss interrupt communications?

**Table 29 Fault Display and Possible Solutions**

LED Operator Display		Fault Name
<i>bUS</i>	bUS	MECHATROLINK-II Option Communication Error
		After establishing initial communication, the connection was lost. Only detected when the run command or frequency reference is assigned to the option (b1-01 = 3 or b1-02 = 3).
Cause		Possible Solution
Master controller (PLC) has stopped communicating.		Check for any faulty wiring. ⇒ Correct any wiring problems.
Communication cable is not connected properly.		⇒ Take care of any grounding problems or disconnects wires.
A data error occurred due to noise		Check the various options available to minimize the effects of noise. ⇒ Take steps to counteract noise in the control circuit wiring, main circuit lines, and ground wiring. ⇒ If the magnetic contactor is identified as a source of noise, install a surge absorber to the contactor coil. ⇒ Use cables recommended by Yaskawa, or another type of shielded line. The shield should be grounded on the PLC side and on the option unit side.
MECHATROLINK-II Option is damaged.		⇒ If there are no problems with the wiring and the error continues to occur, replace the MECHATROLINK-II Option.

LED Operator Display		Fault Name
<i>E5</i>	E5	SI-T3 Watchdog Timer Error
		The watchdog has timed out.
Cause		Possible Solution
Data has not been received from the PLC, triggering the watchdog timer.		Execute DISCONNECT or ALM_CLR, then issue a CONNECT command or SYNC_SET command and proceed to phase 3.

LED Operator Display		Fault Name
<i>EF0</i>	EF0	External Fault Input from MECHATROLINK-II Option
		The alarm function for an external device has been triggered.
Cause		Possible Solution
An external fault is being sent from the master controller (PLC).		⇒ Remove the cause of the external fault. ⇒ Reset the external fault input from the PLC device.
Problem with the PLC program		⇒ Check the program used by the PLC and make the appropriate corrections.

LED Operator Display		Fault Name
<i>oFA00</i>	oFA00	MECHATROLINK-II Option Fault
		MECHATROLINK-II Option is not properly connected.
Cause		Possible Solution
Non-compatible option connected to the drive		⇒ Connect an option that is compatible with the drive.

## 9 Troubleshooting

LED Operator Display		Fault Name
<i>oFA01</i>	oFA01	MECHATROLINK-II Option Fault
		MECHATROLINK-II Option is not properly connected.
Cause		Possible Solution
Problem with the connectors between the drive and MECHATROLINK-II Option		⇒ Turn the power off and check the connectors between the drive and MECHATROLINK-II Option.

LED Operator Display		Fault Name
<i>oFA03</i>	oFA03	MECHATROLINK-II Option Fault
		MECHATROLINK-II Option self-diagnostics error
Cause		Possible Solution
MECHATROLINK-II Option hardware fault		⇒ Replace the MECHATROLINK-II Option. Contact Yaskawa for consultation.

LED Operator Display		Fault Name
<i>oFA04</i>	oFA04	MECHATROLINK-II Option Fault
		MECHATROLINK-II Option Flash write mode
Cause		Possible Solution
MECHATROLINK-II Option hardware fault		⇒ Replace the MECHATROLINK-II Option. Contact Yaskawa for assistance.

LED Operator Display		Fault Name
<i>oFA30 to oFA43</i>	oFA30 to oFA43	MECHATROLINK-II Option Fault
		Communication ID error
Cause		Possible Solution
MECHATROLINK-II Option hardware fault		⇒ Replace the MECHATROLINK-II Option. Contact Yaskawa for assistance.

### ■ Minor Faults and Alarms

LED Operator Display		Minor Fault Name	
<i>AEr</i>	AEr	Station Address Error	
		MECHATROLINK-II Option is set to an address outside the allowable setting range.	
Cause		Possible Solution	Minor Fault (H2-□□ = 10)
Address outside the specified address range		⇒ Set F6-20 to an address within the specified range.	YES

LED Operator Display		Minor Fault Name	
<i>CALL</i>	CALL	Serial Communication Transmission Error	
		Communication has not yet been established.	
Cause		Possible Solution	Minor Fault (H2-□□ = 10)
Communication wiring is faulty, there is a short circuit, or something is not connected properly.		Check for wiring errors. ⇒ Correct the wiring. ⇒ Remove and ground shorts and reconnect loose wires.	YES
Programming error on the master side		⇒ Check communications at start-up and correct programming errors.	
Communication circuitry is damaged.		Perform a self-diagnostics check. ⇒ Replace the drive if the fault continues to occur.	



# 10 Specifications

## ◆ Specifications

**Table 30 Option Specifications**

<b>Model</b>	SI-T3/V (PCB model: SI-T3)
<b>Access mode</b>	Start-stop synchronization, master/slave method
<b>Communication Speed</b>	10 Mbps (MECHATROLINK-II), 4 Mbps (MECHATROLINK-I)
<b>Transmission cycle</b>	500 μs to 8 ms <1>
<b>Maximum transmission distance</b>	50 m <2>
<b>Minimum wiring distance between stations</b>	0.5 m
<b>Data length</b>	17-byte data transmission or 32-byte data transmission <3>
<b>Maximum number of stations</b>	30 <2> <4>
<b>Ambient Temperature</b>	-10°C to +50°C
<b>Humidity</b>	up to 95% RH (no condensation)
<b>Storage Temperature</b>	-20°C to +60°C (allowed for short-term transport of the product)
<b>Area of Use</b>	Indoors (free of corrosive gas, airborne particles, etc.)
<b>Altitude</b>	Up to 1000 m

<1> For MECHATROLINK-I, a cycle is 2 ms. For MECHATROLINK-II, a cycle is 1 ms to 8 ms for a 32-byte data transmission, and 500 μs to 8 ms for a 17-byte data transmission.

<2> At the maximum transmission distance of 50 m, the maximum number of stations is 15.

<3> For MECHATROLINK-I, only a 17-byte data transmission can be selected.

<4> The maximum number of connectable stations changes depending on the types and settings of the host controller, baud rate, or communications cycle. For details, refer to the manuals of your controller.

Communications cycle: Integral multiple of transmission cycles (depending on the host controller settings).

Example: If the host controller is an MP2300

- For MECHATROLINK-II (32-byte transmission, 2.0 ms communications cycle): 21 stations max. (21 stations can be set, but then the maximum number of connectable drives will be 16.)

- For MECHATROLINK-II (32-byte transmission, 1.0 ms communications cycle): 9 stations max.

- For MECHATROLINK-II (17-byte transmission, 1.0 ms communications cycle): 15 stations max.

- For MECHATROLINK-I: 14 stations max.

### ◆ Revision History

The revision dates and numbers of the revised manuals are given on the bottom of the back cover.

MANUAL NO. SIEP C730600 49A

Published in Japan November 2008 08-11

└ Date of  
publication

└ Date of original  
publication

Date of Publication	Rev. No.	Section	Revised Content
November 2008	—	—	First edition

# YASKAWA AC Drive-V1000 Option MECHATROLINK-II Technical Manual

---

**IRUMA BUSINESS CENTER (SOLUTION CENTER)**

480, Kamifujisawa, Iruma, Saitama 358-8555, Japan  
Phone 81-4-2962-5696 Fax 81-4-2962-6138

**YASKAWA ELECTRIC AMERICA, INC.**

2121 Norman Drive South, Waukegan, IL 60085, U.S.A.  
Phone 1-847-887-7000 Fax 1-847-887-7370

**YASKAWA ELÉTRICO DO BRASIL LTDA.**

Avenida Fagundes Filho, 620 São Paulo-SP CEP 04304-000, Brazil  
Phone 55-11-3585-1100 Fax 55-11-5581-8795

**YASKAWA ELECTRIC EUROPE GmbH**

Hauptstraße 185, 65760 Eschborn, Germany  
Phone 49-6196-569-300 Fax 49-6196-569-398

**YASKAWA ELECTRIC UK LTD.**

1 Hunt Hill Orchardton Woods Cumbernauld, G68 9LF, United Kingdom  
Phone 44-1236-735000 Fax 44-1236-458182

**YASKAWA ELECTRIC KOREA CORPORATION**

7F, Doore Bldg. 24, Yeoido-dong, Youngdungpo-Ku, Seoul 150-877, Korea  
Phone 82-2-784-7844 Fax 82-2-784-8495

**YASKAWA ELECTRIC (SINGAPORE) PTE. LTD.**

151 Lorong Chuan, #04-01, New Tech Park 556741, Singapore  
Phone 65-6282-3003 Fax 65-6289-3003

**YASKAWA ELECTRIC (SHANGHAI) CO., LTD.**

No.18 Xizang Zhong Road, Room 1702-1707, Harbour Ring Plaza Shanghai 200001, China  
Phone 86-21-5385-2200 Fax 86-21-5385-3299

**YASKAWA ELECTRIC (SHANGHAI) CO., LTD. BEIJING OFFICE**

Room 1011A, Tower W3 Oriental Plaza, No.1 East Chang An Ave.,  
Dong Cheng District, Beijing 100738, China  
Phone 86-10-8518-4086 Fax 86-10-8518-4082

**YASKAWA ELECTRIC TAIWAN CORPORATION**

9F, 16, Nanking E. Rd., Sec. 3, Taipei, Taiwan  
Phone 886-2-2502-5003 Fax 886-2-2505-1280



YASKAWA

YASKAWA ELECTRIC CORPORATION

In the event that the end user of this product is to be the military and said product is to be employed in any weapons systems or the manufacture thereof, the export will fall under the relevant regulations as stipulated in the Foreign Exchange and Foreign Trade Regulations. Therefore, be sure to follow all procedures and submit all relevant documentation according to any and all rules, regulations and laws that may apply.

Specifications are subject to change without notice for ongoing product modifications and improvements.

© 2008 YASKAWA ELECTRIC CORPORATION. All rights reserved.

MANUAL NO. SIEP C730600 49A

Published in Japan November 2008 08-11  
08-5-3

## Errata

Listed below are corrections for the MECHATROLINK-II (SI-T3/V) Technical Manual (SIEP C730600 49A). Please correct your manual accordingly.

(1) MECHATROLINK-II Commands CONNECT:0EH(Connect) MECHATROLINK-II (VER=21H) (p.27)

### (ERROR)

**When the transmission cycle is equal to the communications time (COM\_TIM = 1):**

- 32-byte data transmission

$$1 \text{ [ms]} \leq \text{transmission cycle [ms]} \leq 8 \text{ [ms]}$$

If the transmission cycle is set to a fractional value, a warning (Data setting warning: A.94) is generated.

- 17-byte data transmission

$$0.5 \text{ [ms]} \leq \text{transmission cycle [ms]} \leq 8 \text{ [ms]}$$

If the transmission cycle is not set to a multiple of 0.5 ms, such as 0.75, a warning (Data setting warning: A.94) is generated.

**When the transmission cycle is not equal to the communications time ( $1 < \text{COM\_TIM} \leq 32$ ):**

$$2 \text{ [ms]} \leq \text{transmission cycle [ms]} \times \text{COM\_TIM} \leq 100 \text{ [ms]}$$

If the transmission cycle is less than 2 ms and is set to a fractional value, a warning (Data setting warning: A.94) is generated. If the communications cycle is set to a fractional value, a warning (Data setting warning: A.94) is generated.

### (CORRECTION)

**When the transmission cycle is equal to the communications time (COM\_TIM = 1):**

- 32-byte data transmission

$$1 \text{ [ms]} \leq \text{transmission cycle [ms]} \leq 8 \text{ [ms]}$$

If the transmission cycle is set to a fractional value, a warning (Data setting warning: A.94) is generated.

- 17-byte data transmission

$$0.5 \text{ [ms]} \leq \text{transmission cycle [ms]} \leq 8 \text{ [ms]}$$

If the transmission cycle is not set to a multiple of 0.5 ms, such as 0.75, a warning (Data setting warning: A.94) is generated.

**When the transmission cycle is not equal to the communications time ( $\text{COM\_TIM} \neq 1$ ):**

A warning (Data setting warning: A.94) is generated.

(2) MECHATROLINK-II Commands CONNECT:0EH(Connect) MECHATROLINK-I (VER=10H) (p.28)

### (ERROR)

#### COM\_TIM

In MECHATROLINK-I, COM\_TIM was set in multiples of two because the units for COM\_TIM were 1 = 1 ms and transmission cycles were fixed at 2 ms.

$$2 \text{ [ms]} \leq \text{COM\_TIM} \leq 64 \text{ [ms]}$$

When transferring data in 2 ms cycles, set COM\_TIM = 2. To use 4 ms cycles, set COM\_TIM = 4.

In the following cases, a warning is generated and the command is ignored. Commands are also ignored in phase 2 (with no alarm).

- If COM\_TIM is set out of range: Data setting warning (A.94)

### (CORRECTION)

#### COM\_TIM

In MECHATROLINK-I, COM\_TIM = 2 because the units for COM\_TIM were 1 = 1 ms and transmission cycles were fixed at 2 ms.

If COM\_TIM  $\neq$  2: Data setting warning (A.94)